

Article number: 439600070

Description: Rota-fix shaft-hub connection FS70x110

Note: Self centering - very high torque.

Measures

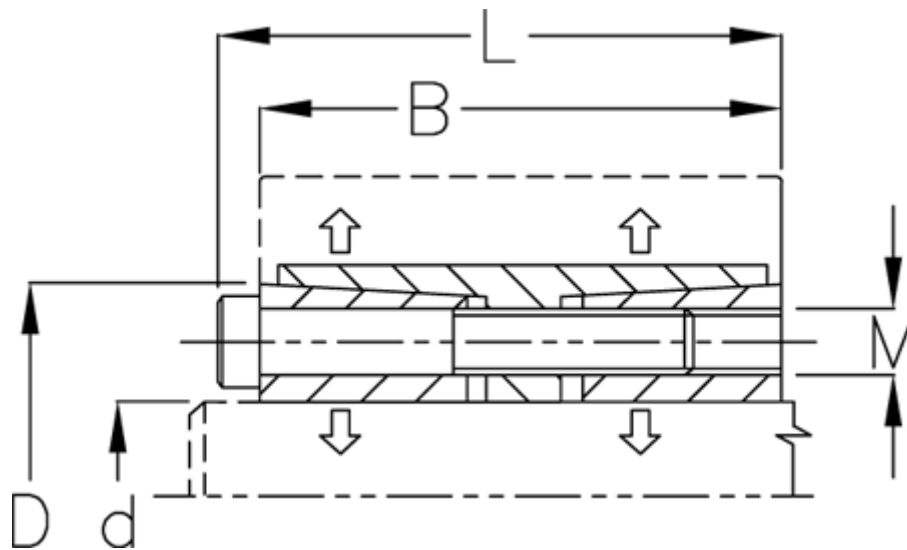

B mm	= 62
d H8 mm	= 70
D mm	= 110
Fit tolerance	= Aksel h8, Nav H8
F kN torque	= 208.0
L mm	= 72
M mm	= M10
P N/mm ² surface pressure on shaft/hub	= 125

Surface roughness	= R? ? 3.2 μ m
T N m torque	= 7270
Ts N m bolt tightening torque	= 83.0